

12 11 10 9 8 7 6 5 4 3 2 1

REV	DESCRIPTION	DATE	DESIGNED
-2	Drawing Renewal	Dec. 26, 2000	K. Yeass

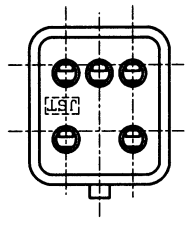

NOTE
 1. Unless otherwise specified, tolerances are:
 25:±0.15D, L2
 13:±0.13
 2. Location of circuit number.

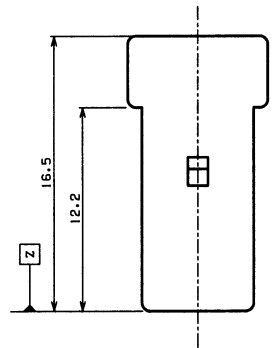
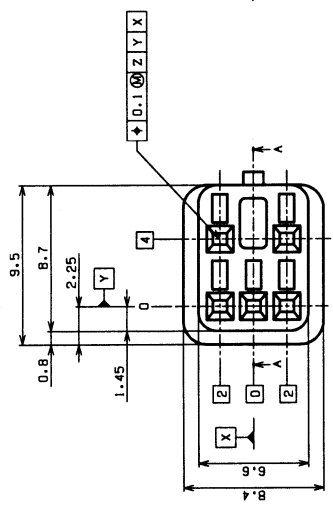
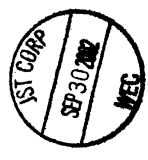
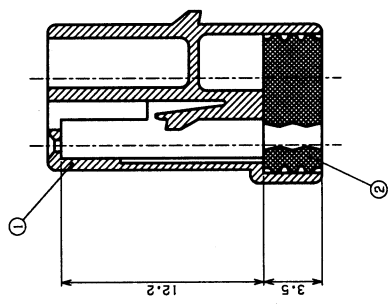
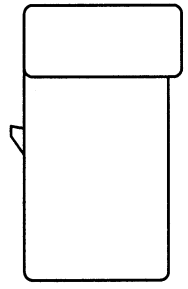
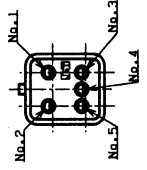

2	Seal Rubber Plate	SI (Light Blue)	
1	Receptacle Housing	PBT (Gray)	UL94HB
REMARKS		SURFACE FINISH	
CUSTOMER		CUSTOMER	
NO.	PART NAME	MATERIAL	DATE
A2	METRIC	10:1	DEC. 26, 2000
APPROVED	CHECKED	DESIGNED	DRAWN
A. Tomita		K. Yeass	N. Mervet
SERIES		RECEPTACLE HOUSING ASSEMBLY, JEPF CONNECTOR	
PART No.		05R-JWPF-HHLE-0	
DRAWING No.		KRD-25666-2	
J. S. T. MFG. CO., LTD		RD	

THIS DRAWING CONTAINS INFORMATION THAT IS PROPRIETARY TO J.S.T. AND SHOULD NOT BE USED WITHOUT WRITTEN PERMISSION.

EC4113-2